

Operating Instructions Portable CD Player

SL-SW965V



Dear Customer

Thank you for purchasing this product. Before connecting, operating or adjusting this product, please read these instructions completely. Please keep this manual for future reference.

Playing MP3

This unit can play MP3 files you have recorded to discs. MPEG Layer-3 audio decoding technology licensed from Fraunhofer IIS and Thomson multimedia.

HOLD

This function causes the unit to ignore accidental button presses. Set to HOLD so the unit doesn't power on accidentally or interrupt play.

Note on CD-R and CD-RW

This unit can play CD-R and CD-RW recorded with CD-DA or MP3. Use an audio recording disc for CD-DA and finalize* it when you finish recording. The unit may not be able to play some discs due to the condition of the recording.

*A process performed after recording that enables CD-R/CD-RW players to play audio CD-R and CD-RW.

Resume function

Play begins from the last point stopped. Replacing the disc cancels the function.

Auto off function

If the unit is left in stop mode for approximately 10 minutes, the unit turns itself off automatically.

P PC En

Panasonic Consumer Electronics Company,
Division of Matsushita Electric Corporation of America
One Panasonic Way Secaucus, New Jersey 07094 <http://www.panasonic.com>

RQT7551-P
F0204TRO

Panasonic Sales Company,
Division of Matsushita Electric of Puerto Rico, Inc. ("PSC")
Ave. 65 de Infantería, Km. 9.5 San Gabriel Industrial Park, Carolina, Puerto Rico 00985
Panasonic Canada Inc.
5770 Ambler Drive, Mississauga, Ontario L4W 2T3 www.panasonic.ca
© 2004 Matsushita Electric Industrial Co., Ltd.
Printed in Japan

The model number and serial number of this product can be found on either the back or the bottom of the unit.

Please note them in the space provided below and keep for future reference.

MODEL NUMBER SL-SW965V
SERIAL NUMBER _____

Troubleshooting guide

Before requesting service, make the following checks. If you are in doubt about some of the check points, or if the remedies indicated in the chart do not solve the problem, refer to the "Customer Services Directory" on page 4 if you reside in the U.S.A., or refer to the "Product information" on page 4 if you reside in Canada.

No play.	<ul style="list-style-type: none"> •The HOLD function is on. Release HOLD (⇄page 5). •The batteries may have run empty (⇄page 5). (If play is extremely short even after fully recharging the batteries, the batteries may have exceeded their life. Rechargeable batteries can be recharged approximately 300 times.) •The disc isn't correctly set. •The disc is scratched or dirty. (Tracks skipped.) •There is moisture on the lens. Wait for about an hour and then try again. •The lens is dirty: clean it with a blower (recommended product: SZZP1038C). If the lens gets marked with fingerprints, gently wipe them off with a cotton swab. •The unit may not read MP3 correctly if it is shaken while it is reading the files. •Play of a multi-session disc may not be possible if there is a blank data segment between sessions. •If there is large JPEG data etc. within a MP3 file, sound may become muted and play may not be possible. •If you try playing a CD that contains CD-ROM format data and normal audio data (CD-DA), output from one of the above may become silent, and play may not be possible.
No sound or there is a lot of noise.	<ul style="list-style-type: none"> •Ensure the plugs are inserted firmly. •Wipe the plugs clean with a clean cloth. •Noise may occur when playing MP3 if recording quality is poor. •The elapsed playing time disappears and sound is interrupted if bumps continue repeatedly. •Separate this unit from mobile telephones.
Play doesn't resume from the last point stopped.	<ul style="list-style-type: none"> •This doesn't work if you change discs. •This doesn't work during random play. •It may not work correctly under some conditions.
Play doesn't start from the first track.	<ul style="list-style-type: none"> •Random play modes may be on (⇄page 6). •Play resumes from the last point stopped (⇄above).
The unit stops working.	Disconnect then reconnect all power sources (batteries and AC adaptor).
Cannot search through tracks.	You cannot search through MP3 files.
Cannot skip albums.	You cannot skip between the first and last albums during play.

Cannot change the Digital Re-master mode, anti-skip mode.	If [◀◀] or [▶▶] is pressed before [MEMORY/RECALL] you cannot change the mode.
Digital Re-master does not work.	Depending on the type of MP3 disc recording, the effect may not appear.
Cannot recharge.	<ul style="list-style-type: none"> •You aren't using the special rechargeable batteries (⇄page 5). •You must insert two batteries before you can recharge them. •The unit must be off before you can recharge.
The AC adaptor becomes warm during recharging.	This is normal.
The batteries are taking a long time to recharge.	The batteries may take a maximum of 6 hours to recharge under some conditions.
Play time is short after recharging.	<ul style="list-style-type: none"> •This may occur after the first time you recharge the batteries or haven't used them for a long time. Play time should be restored after a few recharges. •The batteries can go flat if you leave the AC adaptor connected after recharging is complete.
The battery indicator fails to appear or is incorrect.	<ul style="list-style-type: none"> •The indicator does not appear when the AC adaptor is connected. •The indicator does not appear correctly under some conditions.
Radio reception is noisy.	<ul style="list-style-type: none"> •Keep the unit away from other tuners and televisions. •The AM antenna is in the unit, so noise may increase if you hold the unit.

Display

<i>hold</i>	The HOLD function is on. Release HOLD (⇄page 5).
<i>no disc</i>	<ul style="list-style-type: none"> •You haven't inserted a disc or it isn't inserted correctly. •You have inserted a disc this unit cannot play.
<i>OPEN</i>	The disc lid is open.
<i>F</i>	The program already contains 20 tracks.
<i>]</i>	Reading MP3 files.

Location of controls/Connection to other equipment

Turn off this unit and the other equipment before connection.

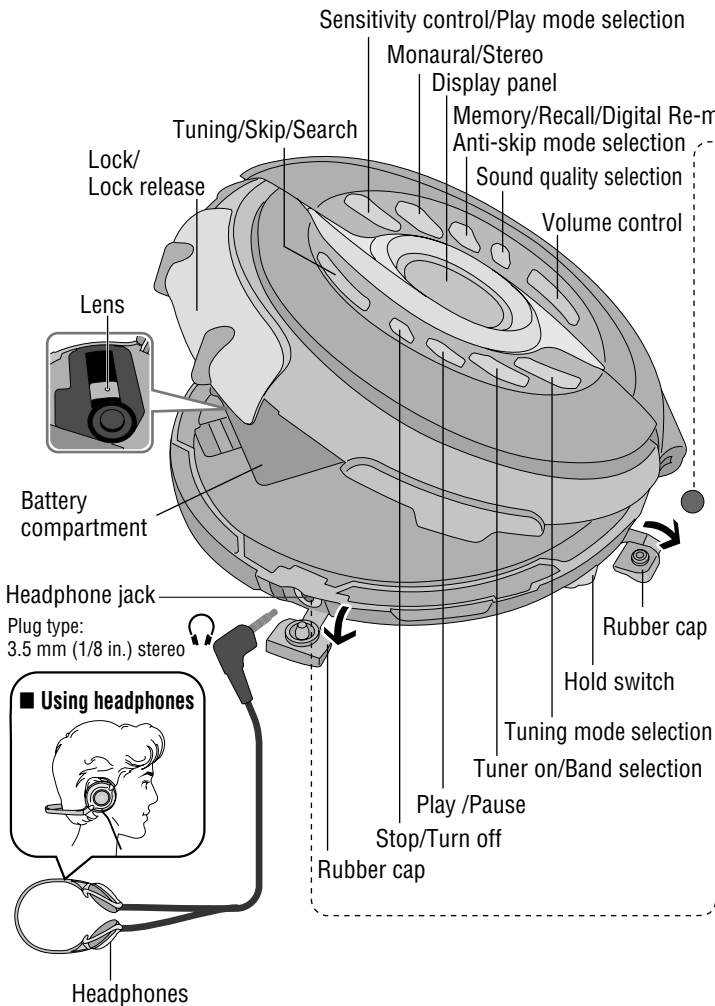

To DC IN jack

AC adaptor (RP-AC46) (not included)
Connect the AC adaptor to the household AC outlet first.

Household AC outlet

Car power adaptor (SH-CDC9) (not included)
You can recharge the batteries with this connection.

Car audio

Noise may occur when using the car power adaptor and listening to the radio.



Some cannot be connected.

To headphone jack (Ω)

Car stereo cassette adaptor (SH-CDM10A) (not included)
Set the unit's volume to 10-15.

Audio system

Audio cable (not included)
Set the unit's volume to 10-15.

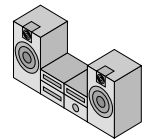

Adjust the volume on the audio system.

Supplied Accessories

Check the packing carton for these accessories.

- 1 Pair of stereo headphones: LOBAD0000168
- 1 Hand strap: RGQT0006-K1

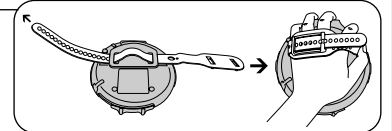

Use numbers indicated when ordering replacements or optional accessories from your Panasonic dealer.

In U.S.A. to order accessories refer to "Accessory Purchases" on page 4.

Specifications

CD SECTION

■ **CD-DA**
Sampling frequency: 44.1 kHz
No. of channels: 2 (left and right, stereo)
Headphone output level:
RMS max. 6 mW+6 mW/
16 Ω (adjustable)
Frequency response:
20 Hz to 20,000 Hz
(0 dB to -3.5 dB)

■ MP3

Supported bit-rates:
32 kbps to 320 kbps
(128 kbps is recommended)
Supported sampling frequency:
48 kHz/44.1 kHz/32 kHz
Maximum number of items
(total no. of albums and tracks): 999
Maximum album levels: 100

■ Pickup

Light source: Semiconductor laser
Wavelength: 780 nm

RADIO SECTION

■ **Frequency**
Radio frequency:
FM: 87.90-107.90 MHz
(0.2 MHz steps)
87.50-108.00 MHz
(0.1 MHz/0.05 MHz steps)
AM: 520-1710 kHz
(10 kHz steps)
522-1629 kHz
(9 kHz steps)

GENERAL

Power supply:
DC input (AC adaptor, not included):
DC 4.5 V
Operational temperature range:
0 °C-40 °C (32 °F-104 °F)
Rechargeable temperature range:
5 °C-40 °C (41 °F-104 °F)

Play time:
Using on a flat stable surface at 25 °C (77 °F), S-XBS is off, Hold is on, Anti-skip is on POS 1 (CD-DA), recommended bit rate (MP3:128 kbps), and Digital Re-master is off (MP3). Play times are in hours and approximate.

Batteries used	MP3 disc	CD-DA disc	RADIO (FM BAND)
2 optional alkaline batteries	75	33	75
2 optional rechargeable batteries	34	16	30

Recharging time: About 4 to 5 hours
● The play time may be less depending on the operating conditions.
● Play time will be considerably reduced when playing CD-RW.
Dimensions (W×H×D):
142×29.7×142 mm
(5⁹/₁₆"×1³/₁₆"×5⁹/₁₆"

Mass:
336 g (11.9 oz.)(with batteries)
290 g (10.2 oz.)(without batteries)

Note:
Specifications are subject to change without notice.
Mass and dimensions are approximate.

IMPORTANT SAFETY INSTRUCTIONS

Read these operating instructions carefully before using the unit. Follow the safety instructions on the unit and the applicable safety instructions listed below. Keep these operating instructions handy for future reference.

- 1) Read these instructions.
- 2) Keep these instructions.
- 3) Heed all warnings.
- 4) Follow all instructions.
- 5) Do not use this apparatus near water.
- 6) Clean only with dry cloth.
- 7) Do not block any ventilation openings. Install in accordance with the manufacturer's instructions.
- 8) Do not install near any heat sources such as radiators, heat registers, stoves, or other apparatus (including amplifiers) that produce heat.
- 9) Do not defeat the safety purpose of the polarized or grounding-type plug. A polarized plug has two blades with one wider than the other. A grounding-type plug has two blades and a third grounding prong. The wide blade or the third prong are provided for your safety. If the provided plug does not fit into your outlet, consult an electrician for replacement of the obsolete outlet.
- 10) Protect the power cord from being walked on or pinched particularly at plugs, convenience receptacles, and the point where they exit from the apparatus.
- 11) Only use attachments/accessories specified by the manufacturer.
- 12) Use only with the cart, stand, tripod, bracket, or table specified by the manufacturer, or sold with the apparatus. When a cart is used, use caution when moving the cart/apparatus combination to avoid injury from tip-over.
- 13) Unplug this apparatus during lightning storms or when unused for long periods of time.
- 14) Refer all servicing to qualified service personnel. Servicing is required when the apparatus has been damaged in any way, such as power-supply cord or plug is damaged, liquid has been spilled or objects have fallen into the apparatus, the apparatus has been exposed to rain or moisture, does not operate normally, or has been dropped.



Caution

■Water Resistant (Splash Proof)

The main unit and headphones are splash proof, however damage may result if water gets inside them.

- Do not use in water or splash with salt water or a lot of water.
- Wipe off water, dust or sand from the unit before opening and closing the lid.
- Slide the lock to close the lid securely.
- Insert the rubber caps into the headphone and DC IN jacks when not using the unit.

■Batteries

- Do not peel off the covering on the batteries and do not use if the covering has been peeled off.
- Align the poles + and – correctly when inserting the batteries.
- Do not mix different types of batteries or old and new batteries.
- Remove the batteries if you do not intend to use the unit for a long time.
- Do not throw into a fire, short-circuit, disassemble, or subject to excessive heat.
- Do not attempt to recharge dry cell batteries.
- When carrying batteries in a pocket or bag, ensure no metal objects such as necklaces are placed together with them. Contact with metal may cause short-circuiting which can cause a fire.

■CDs

- Do not use irregularly shaped CDs.
- Do not use non-specification discs.
- Do not use CDs printed with label printers available on the market.
- Do not use CDs with labels and stickers that are coming off or with adhesive exuding from under labels and stickers.

■Listening



Do not play your headphones or earphones at a high volume. Hearing experts advise against continuous extended play. If you experience a ringing in your ears, reduce volume or discontinue use.

Do not use while operating a motorized vehicle. It may create a traffic hazard and is illegal in many areas.

You should use extreme caution or temporarily discontinue use in potentially hazardous situations.

Even if your headphones or earphones are the open-air type designed to let you hear outside sounds, don't turn up the volume so high that you can't hear what's around you.

Sound can be deceiving. Over time your hearing "comfort level" adapts to higher volumes of sound. So what sounds "normal" can actually be loud and harmful to your hearing.

Guard against this by setting your equipment at a safe level BEFORE your hearing adapts.

To establish a safe level:

- Start your volume control at a low setting.
- Slowly increase the sound until you can hear it comfortably and clearly, and without distortion.

Once you have established a comfortable sound level:

- Leave it there.

■Allergies

Discontinue use if you experience discomfort with the earphones or any other parts that directly contact your skin. Continued use may cause rashes or other allergic reactions.

WARNING:

TO REDUCE THE RISK OF FIRE, ELECTRIC SHOCK OR PRODUCT DAMAGE, DO NOT EXPOSE THIS APPARATUS TO RAIN, MOISTURE, DRIPPING OR SPLASHING AND THAT NO OBJECTS FILLED WITH LIQUIDS, SUCH AS VASES, SHALL BE PLACED ON THE APPARATUS.

CAUTION!

THIS PRODUCT UTILIZES A LASER. USE OF CONTROLS OR ADJUSTMENTS OR PERFORMANCE OF PROCEDURES OTHER THAN THOSE SPECIFIED HEREIN MAY RESULT IN HAZARDOUS RADIATION EXPOSURE. DO NOT OPEN COVERS AND DO NOT REPAIR YOURSELF. REFER SERVICING TO QUALIFIED PERSONNEL.

CAUTION:

Use only car adaptor, Model: SH-CDC9 manufactured by Matsushita Electric Industrial Co., Ltd.

Marking sign is located on bottom of the unit.

THE FOLLOWING APPLIES ONLY IN THE U.S.A.

CAUTION:

This equipment has been tested and found to comply with the limits for a Class B digital device, pursuant to Part 15 of the FCC Rules.

These limits are designed to provide reasonable protection against harmful interference in a residential installation. This equipment generates, uses and can radiate radio frequency energy and, if not installed and used in accordance with the instructions, may cause harmful interference to radio communications. However, there is no guarantee that interference will not occur in a particular installation. If this equipment does cause harmful interference to radio or television reception, which can be determined by turning the equipment off and on, the user is encouraged to try to correct the interference by one or more of the following measures:

- Reorient or relocate the receiving antenna.
- Increase the separation between the equipment and receiver.
- Connect the equipment into an outlet on a circuit different from that to which the receiver is connected.
- Consult the dealer or an experienced radio/TV technician for help.

Any unauthorized changes or modifications to this equipment would void the user's authority to operate this device.

This device complies with Part 15 of the FCC Rules. Operation is subject to the following two conditions: (1) This device may not cause harmful interference, and (2) this device must accept any interference received, including interference that may cause undesired operation.

Product service

- 1. Damage requiring service**—The unit should be serviced by qualified service personnel if:
 - (a) The AC power supply cord or AC adaptor has been damaged; or
 - (b) Objects or liquids have gotten into the unit; or
 - (c) The unit has been exposed to rain; or
 - (d) The unit does not operate normally or exhibits a marked change in performance; or
 - (e) The unit has been dropped or the cabinet damaged.
- 2. Servicing**—Do not attempt to service the unit beyond that described in these operating instructions. Refer all other servicing to authorized servicing personnel.
- 3. Replacement parts**—When parts need replacing ensure the servicer uses parts specified by the manufacturer or parts that have the same characteristics as the original parts. Unauthorized substitutes may result in fire, electric shock, or other hazards.
- 4. Safety check**—After repairs or service, ask the servicer to perform safety checks to confirm that the unit is in proper working condition.

Product information

For product information or assistance with product operation: In the U.S.A., refer to "Customer Services Directory" below.

For assistance in the continental U.S.A. in obtaining repairs please ship the product to:

Panasonic Services Company - Customer Servicer
Suite B 4900 George McVay Drive
McAllen, TX 78503

In Puerto Rico contact the Panasonic Sales Company.

Tel. (787) 750-4300 Fax. (787) 768-2910

When shipping the unit carefully pack and send it prepaid, adequately insured and preferably in the original carton. Include a letter detailing the complaint and provide a day time phone number where you can be reached.

IF REPAIR IS NEEDED DURING THE WARRANTY PERIOD THE PURCHASER WILL BE REQUIRED TO FURNISH A SALES RECEIPT/PROOF OF PURCHASE INDICATING DATE OF PURCHASE, AMOUNT PAID AND PLACE OF PURCHASE. CUSTOMER WILL BE CHARGED FOR THE REPAIR OF ANY UNIT RECEIVED WITHOUT SUCH PROOF OF PURCHASE.

Also, the purchaser will be responsible for shipping the unit to the above address.

In Canada, contact the Panasonic Canada Inc. Customer Care Centre at 905-624-5505, or visit the website (www.panasonic.ca), or an authorized Servicer closest to you.

User memo:

DATE OF PURCHASE	_____
DEALER NAME	_____
DEALER ADDRESS	_____
TELEPHONE NUMBER	_____

Panasonic Consumer Electronics Company,
Division of Matsushita Electric Corporation of America
One Panasonic Way Secaucus, New Jersey 07094

ONLY FOR U.S.A.

Panasonic Sales Company, Division of Matsushita Electric
of Puerto Rico, Inc.,
Ave. 65 de Infantería, Km. 9.5
San Gabriel Industrial Park, Carolina, Puerto Rico 00985

Panasonic Portable Audio Products Limited Warranty

Limited Warranty Coverage

If your product does not work properly because of a defect in materials or workmanship, Panasonic Consumer Electronics Company or Panasonic Sales Company (collectively referred to as "the warrantor") will, for the length of the period indicated on the chart below, which starts with the date of original purchase ("warranty period"), at its option either (a) repair your product with new or refurbished parts, or (b) replace it with a new or a refurbished product. The decision to repair or replace will be made by the warrantor.

Product or Part Name	Parts	Labor
All Portable Audio Products except item listed below	One (1) Year	One (1) Year
Rechargeable batteries (in exchange for defective item)	Ten (10) Days	Not applicable

During the "Labor" warranty period there will be no charge for labor. During the "Parts" warranty period, there will be no charge for parts. You must mail-in your product during the warranty period. This Limited Warranty excludes both parts and labor for batteries, antennas, and cosmetic parts (cabinet). This warranty only applies to products purchased and serviced in the United States or Puerto Rico. This warranty is extended only to the original purchaser of a new product which was not sold "as is".

Mail-In Service

For assistance in the continental U.S.A. in obtaining repairs please ship the product to:

Panasonic Services Company
Customer Servicer
Suite B
4900 George McVay Drive
McAllen, TX 78503

For assistance in Puerto Rico call Panasonic Sales Company (787)-750-4300 or fax (787)-768-2910.

When shipping the unit carefully pack and send it prepaid, adequately insured and preferably in the original carton. Include a letter detailing the complaint and provide a day time phone number where you can be reached.

Customer Services Directory

Obtain Product Information and Operating Assistance; locate your nearest Dealer or Servicer; purchase Parts and Accessories; or make Customer Service and Literature requests by visiting our Web Site at:

<http://www.panasonic.com/support>

or, contact us via the web at:

<http://www.panasonic.com/contactinfo>

You may also contact us directly at:

1-800-211-PANA (7262),

Monday-Friday 9 am-9 pm; Saturday-Sunday 10 am-7 pm, EST.

For hearing or speech impaired TTY users, TTY : 1-877-833-8855

IF REPAIR IS NEEDED DURING THE WARRANTY PERIOD THE PURCHASER WILL BE REQUIRED TO FURNISH A SALES RECEIPT/PROOF OF PURCHASE INDICATING DATE OF PURCHASE, AMOUNT PAID AND PLACE OF PURCHASE. CUSTOMER WILL BE CHARGED FOR THE REPAIR OF ANY UNIT RECEIVED WITHOUT SUCH PROOF OF PURCHASE.

Limited Warranty Limits And Exclusions

This warranty ONLY COVERS failures due to defects in materials or workmanship, and DOES NOT COVER normal wear and tear or cosmetic damage. The warranty ALSO DOES NOT COVER damages which occurred in shipment, or failures which are caused by products not supplied by the warrantor, or failures which result from accidents, misuse, abuse, neglect, mishandling, misapplication, alteration, faulty installation, set-up adjustments, misadjustment of consumer controls, improper maintenance, power line surge, lightning damage, modification, introduction of sand, humidity or liquids, commercial use such as hotel, office, restaurant, or other business or rental use of the product, or service by anyone other than a Factory Servicer or other Authorized Servicer, or damage that is attributable to acts of God.

THERE ARE NO EXPRESS WARRANTIES EXCEPT AS LISTED UNDER "LIMITED WARRANTY COVERAGE". THE WARRANTOR IS NOT LIABLE FOR INCIDENTAL OR CONSEQUENTIAL DAMAGES RESULTING FROM THE USE OF THIS PRODUCT, OR ARISING OUT OF ANY BREACH OF THIS WARRANTY. (As examples, this excludes damages for lost time, travel to and from the servicer, loss of or damage to media or images, data or other memory or recorded content. The items listed are not exclusive, but are for illustration only.)

ALL EXPRESS AND IMPLIED WARRANTIES, INCLUDING THE WARRANTY OF MERCHANTABILITY, ARE LIMITED TO THE PERIOD OF THE LIMITED WARRANTY.

Some states do not allow the exclusion or limitation of incidental or consequential damages, or limitations on how long an implied warranty lasts, so the exclusions may not apply to you. This warranty gives you specific legal rights and you may also have other rights which vary from state to state. If a problem with this product develops during or after the warranty period, you may contact your dealer or Servicer. If the problem is not handled to your satisfaction, then write to the warrantor's Consumer Affairs Department at the addresses listed for the warrantor. **PARTS AND SERVICE, WHICH ARE NOT COVERED BY THIS LIMITED WARRANTY, ARE YOUR RESPONSIBILITY.**

Accessory Purchases

Purchase Parts, Accessories and Instruction Books online for all Panasonic Products by visiting our Web Site at: <http://www.pasc.panasonic.com>

or, send your request by E-mail to: npcparts@panasonic.com

You may also contact us directly at:

1-800-332-5368 (Phone) 1-800-237-9080 (Fax Only) (Monday - Friday 9 am to 8 pm, EST.)

Panasonic Services Company

20421 84th Avenue South, Kent, WA 98032

(We Accept Visa, MasterCard, Discover Card, American Express, and Personal Checks)

For hearing or speech impaired TTY users, TTY : 1-866-605-1277

Service in Puerto Rico

Matsushita Electric of Puerto Rico, Inc. Panasonic Sales Company/Factory Servicer:
Ave. 65 de Infantería, Km. 9.5, San Gabriel Industrial Park, Carolina, Puerto Rico 00985
Phone (787)750-4300, Fax (787)768-2910

Power Supply

Rechargeable batteries (not included) Recharge before initial use.

As a safety precaution this unit is constructed so it is impossible to recharge ordinary batteries. For details, check with your dealer.

Special rechargeable Ni-Cd batteries
P-3GAVA/2B (set of 2)

Ordinary dry cell batteries/
rechargeable batteries

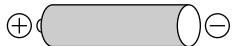

Opening and closing the lid → below
Make sure the unit is off when recharging.

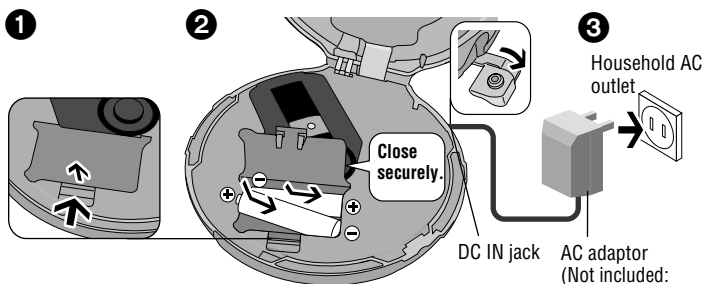

- The battery indicator () scrolls while recharging and disappears when finished (about 4 to 5 hours).
- You can recharge the batteries before they are fully discharged.
- Fit the battery lid so it is secure and flush with the battery compartment. If it comes loose, it may scratch your discs.

Dry cell batteries (not included)

After disconnecting the AC adaptor, insert two “LR6, AA, UM-3” alkaline batteries. Insert the same way as the rechargeable batteries.

The battery indicator

This indicator appears when the unit is on.

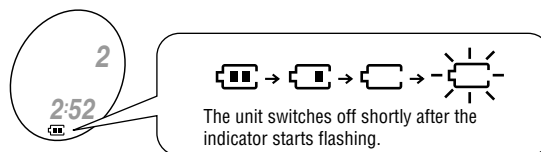

- Before playing starts the battery indicator may flash although the batteries are not drained. It appears correctly once you start play.
- The remaining time may differ when listening to a CD or the radio.

General

■ Removing batteries

■ Play time

⇨ Specifications, page 2

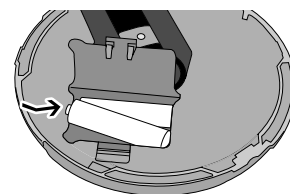

Listening to CDs Basic Play

Playback

Open the lid.

Close the lid.

1 Open, insert a CD and close securely.

2 Release HOLD.

3 Press [▶/||].

4 Adjust the volume. (0 - 25)

5 Track number: 5, Elapsed playing time of track: 1:10

• MP3 files take a little longer to be read.

• “MP3” lights on the display while playing MP3 files.

Pause



Press.

- Press again to restart play.

Search



Press and hold during play.

- You cannot search while playing MP3.
- You can search only within the current track during program, one track repeat, random, random repeat play modes (⇨ page 6).

Skip



Press.

- Press [◀◀] twice to skip to the beginning of the previous track during play.
- You cannot use [◀◀] to skip to the previous track during random play (⇨ page 6).

Stop/Turn off



OPR OFF

Press.

- Press again to turn the unit off.

Number of tracks

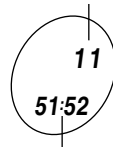

Total play time

MP3 Number of albums

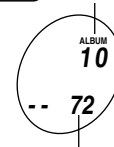

Number of tracks

Program Play

1 Press [- <<<, >>> +] while stopped to select the tracks.
You can skip albums when programming MP3 tracks (⇔ below).

2 Press [MEMORY/RECALL] to register. Track number 3 Sequence number -- 01

3 Repeat steps 1 and 2 to register up to 20 tracks.

4 Press [▶/||] to start play.

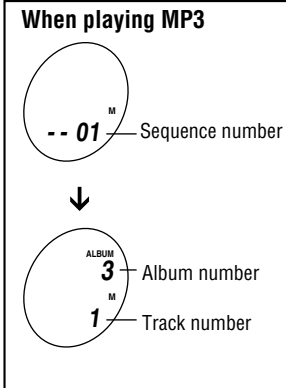

- **To confirm the contents of the program**
Press [MEMORY/RECALL] while the disc is playing.
- **To cancel program play**
Press [■ OPR OFF].

Play modes

Each time you press [PLAY MODE]

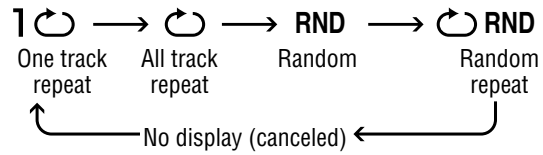
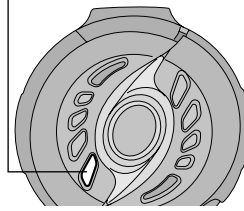

● You cannot select "RND" while playing MP3.

Anti-Skip System

This system reduces skipping caused by vibration to a minimum. You can change the anti-skip memory time for CD-DA to improve sound quality.

While stopped, each time you press and hold [MEMORY/RECALL]

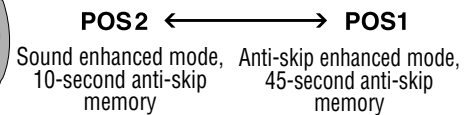
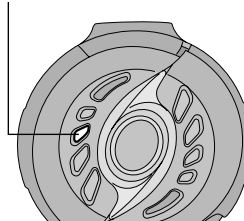

● You cannot change the memory time for MP3. It is a maximum of 100 seconds for data recorded at 128 kbps.

Changing the sound quality

Each time you press [S-XBS]

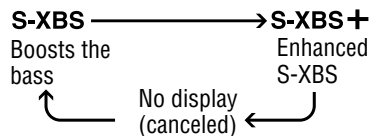
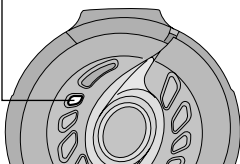

● The effect may differ between different kinds of music.

Listening to CDs **Playing MP3**

Starting play from an album (Album skip)

Press and hold [- <<<, >>> +] until the album you want appears.

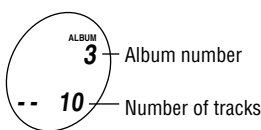
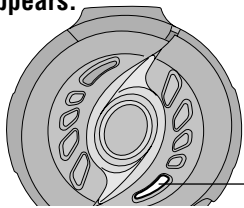

Playing only the tracks in a selected album (Album mode)

Each time you press and hold [PLAY MODE]

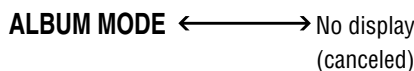
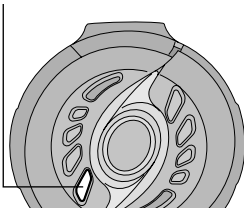

- You can select another album with album skip (⇔ above).
- You cannot turn album mode on during program play.

Enjoying even more natural sound (Digital Re-master)

You can regenerate signal frequency lost during compression, restoring to near pre-compression form.

While stopped, each time you press and hold [MEMORY/RECALL]

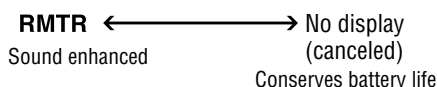
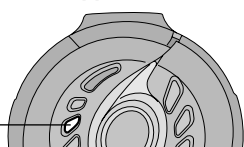

This unit can play MP3, a method of compressing audio without overtly hurting audio quality.

■ **When creating MP3 files to play on this unit**

Disc formats: ISO9660 level 1 and level 2 (except for extended formats)

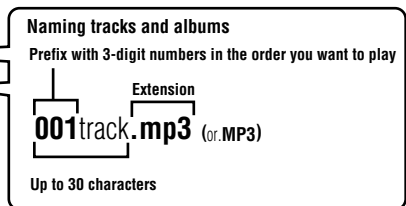
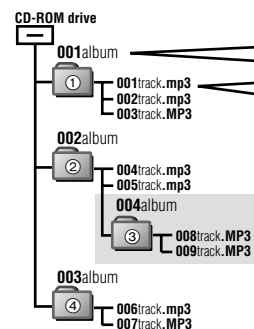

If you created an album such as 004album on the left, the files may not play in name order. The albums would play in the order ①, ②, ③, ④.

■ **Limitations on MP3**

- This unit is compatible with multi-session but if there are a lot of sessions it takes more time for play to start. Keep the number of sessions to a minimum to avoid this.
- This unit cannot play files recorded using packet write.
- If a CD-ROM format CD contains MP3 and files other than MP3, only the MP3 files will be playable.
- Depending on how you create MP3 files, they may not play in the order you numbered them or may not play at all.

Listening to the Radio

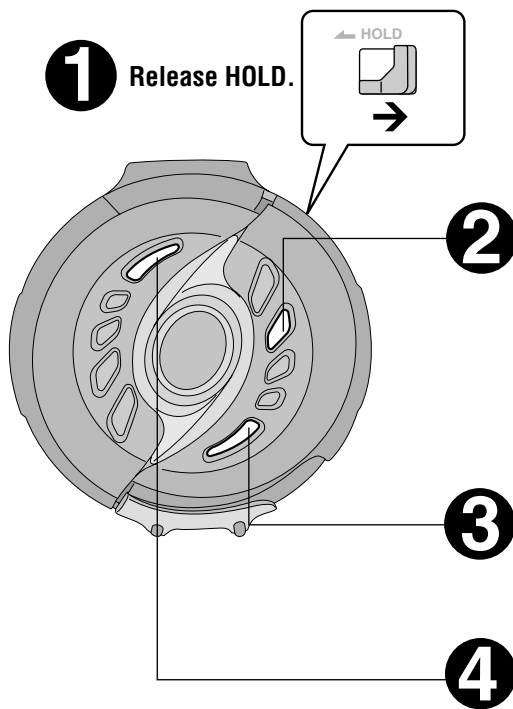

1 Release HOLD.

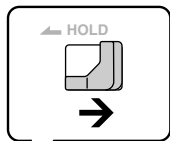

2

Press to turn the tuner on and change the band.

Each time you press the button;
FM ↔ AM

•When “M” is displayed, press [TUNING MODE] to cancel it.

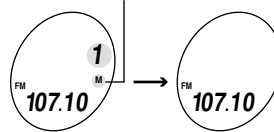

3

Press to select the station.

•Press and hold to scan the stations rapidly.
•“TUNED” appears when tuned.

4

Adjust the volume.

■ **To turn off the radio**

Press [■ OPR OFF].

Storing stations to memory and listening

■ Store stations to memory

Store the frequencies of up to 30 stations; 20 FM and 10 AM.

1 Release HOLD.

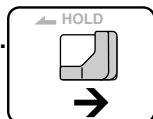

2

Press to turn the tuner on and change the band.

Each time you press the button;
FM ↔ AM

3

Press to display “M”.

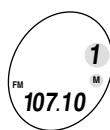

4

Store stations to memory.

① Press [MEMORY/RECALL].



Do each of the following within 10 seconds.

② Press [– |◀◀, ▶▶ | +] to select the frequency.

•Press and hold to scan the stations rapidly.

③ Press [MEMORY/RECALL].

④ Press [– |◀◀, ▶▶ | +] to select the memory number.

•Press and hold to change incrementally.

⑤ Press [MEMORY/RECALL] to confirm the setting.

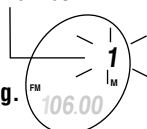

■ Listening to a memorized station

1 Perform steps ① to ③ on the left of the page.

2 Press [– |◀◀, ▶▶ | +] to select the memorized station.

•Press and hold to change incrementally.

•“TUNED” appears when tuned.

3 Adjust the volume.

■ Erasing a memorized station

1 Perform steps ① to ③ on the left of the page.

2 Press [– |◀◀, ▶▶ | +] to select the memorized station to be erased.

3 Press [MEMORY/RECALL].

The frequency number flashes.

Do each of the following within 10 seconds.

4 Press and hold [MEMORY/RECALL] until “- - - -” flashes.

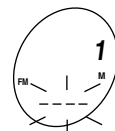

5 Press [MEMORY/RECALL].

Listening to the Radio

To obtain good reception

AM

Try various directions to obtain optimum reception.

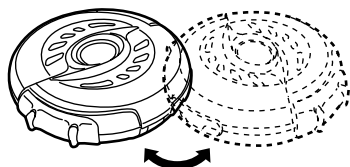

FM

The headphone cord is also the FM antenna, so extend it instead of leaving it coiled.

To receive an FM broadcast clearly

Set to "CITY" if reception is poor or if there is interference from another station.

Each time you press and hold [FM RECEPT \blacksquare CITY/NOR]

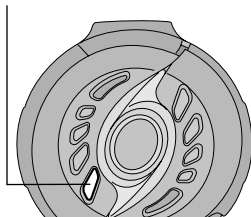

CITY \longleftrightarrow No display
(canceled)

To select stereo or monaural FM

Set to "MONO" when there is noise during FM reception. Sound becomes monaural, but noise is reduced.

Each time you press [FM MONO/ST]

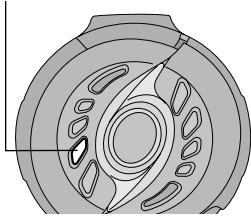

MONO \longleftrightarrow No display
(stereo)

Changing the sound quality

The operation is the same as when playing CDs. (\leftrightarrow page 6)

When using overseas

Change the frequency step according to the area.

Preparation: Press [RADIO/BAND] to switch on the power.

1

Press and hold [RADIO/BAND] until the step appears.

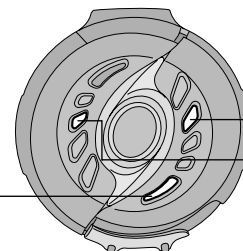

2

Within 10 seconds
Press to select the step.

Each time you press [- \lll , \ggg +]

U0.2 \longleftrightarrow U0.1 \longleftrightarrow E

FM 0.2 MHz, AM 10 kHz (original setting) FM 0.1 MHz, AM 10 kHz FM 0.05 MHz, AM 9 kHz

3

Within 10 seconds
Press and hold [MEMORY/RECALL] until the frequency appears to confirm the step.

■ To return to the previous frequency step

Repeat the above procedure.

● Changing the step erases the stations you stored in memory.